

Пекин / Pekin

Код ТН ВЭД ЕАЭС

9403 60 100 1
9403 90 300 0



отрезать
и приклеить

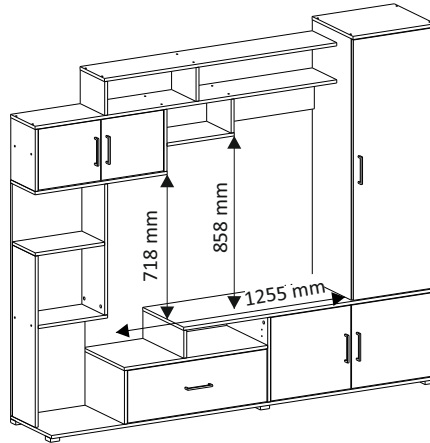

2100	1785	398

43Г / 1321
43Г1 / 1322

Комплектовочная ведомость / Set package sheet

Упак/ Package	Наименование	Description	Цвет детали/ Décor		Размер / Size, mm	Кол-во/ Quantity	№
			Oak gold - White	Wenge - Oak			
1	Фурнитура	Furniture/Cabinetry hardware	-	-	-	1	-
2	Боковина	Side	Oak gold	Wenge	168x238	1	29
	Боковина	Side		Wenge	168x238	2	31
	Боковина	Side		Wenge	138x398	1	8
	Боковина	Side		Oak	266x398	1	7
	Боковина	Side		Oak	1297x378	1	2
	Полка	Shelves		Wenge	416x358	3	4
	Задник	Back element		Wenge	562x184	1	34
	Деталь ящика	Side drawers		Wenge	120x350	2	10
	Деталь ящика	Side drawers		Wenge	120x711	2	11
3	Боковина	Side	Oak gold	Wenge	650x222	1	21
	Боковина	Side			850x222	1	22
	Крыша	Top			380x222	2	20
	Крыша	Top			723x238	1	24
	Крыша	Top			1651x238	1	30
	Вязка	Connecting element			368x238	1	28
	Вязка	Connecting element			1271x238	1	32
4	Боковина левая	Side left	Oak gold	Wenge	308x238	1	25
	Боковина правая	Side right			308x238	1	12
	Боковина	Side			420x398	1	6
	Боковина	Side			1733x398	1	1
	Крыша	Top			450x398	1	3
	Крыша	Top			785x398	1	13
	Крыша	Top			1360x398	1	14
	Крыша	Top			2100x398	1	5
5	ХДФ	Back element	White	Wenge	743x350	1	33
	ХДФ	Back element			790x292	1	19
	ХДФ	Back element			717x334	1	27
	ХДФ	Back element			904x442	1	18
	ХДФ	Back element			1318x444	1	17
6	Панель	Drawer panel	White	Oak	260x762	1	9
	Створка	Door			414x438	2	15
	Створка	Door			1291x428	1	16
	Створка	Door			302x341	2	26
	Задник	Back element			1154x398	1	23

(PL) Instrukcja montażu

(CZ) Návod k montáži

(D) Montageanleitung

(GB) Assembly instruction

(F) Model d'emploi

(HU) Szerelési útmutató

(I) Istruzione di montaggio

(NL) Handleiding voor de montage



(RU) Инструкция по монтажу

(RO) Instrucțiuni de montare

(SK) Návod k montáži

(TR) Montaj talimatı

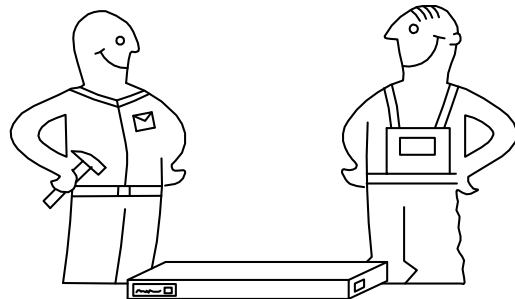
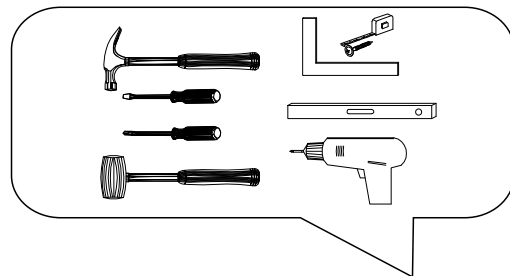

⚠ **Uwaga • Upozornění • Achtung • Attention • Caution • Figyelem**
Attenzione • Opgelet • Внимание • Atenție • Upozornenie • Dikkat ⚠

PL Czyszczenie należy wykonać wyłącznie za pomocą ściereczki lub lekko nawilżonego ręcznika. Nie stosować środków czyszczących do szorowania.

CZ Čistění je nutné vykonávat výhradně pomocí utěrky nebo lehce navlhčeného ručníku. Nepoužívejte čisticí prostředky obsahující abrazivní částice.

D Bitte nur mit einem Staubtuch oder leicht feuchtem Lappen reinigen. Keine scheuernden Putzmittel verwenden.

GB Please only clean with a duster or a damp cloth. Do not use any abrasive cleaners.

F Le nettoyage se fait uniquement à l'aide d'un torchon ou d'une serviette légèrement mouillée.

HU A tisztítás kizárólag törülőruha vagy enyhén nedvesített törölköző segítségével végezhető. Súroló hatású tisztítószerket nem szabad használni.

I Pulire esclusivamente con un panno o un asciugamano umido.

NL Reinig alleen met een stofdoek of een lichtjes vochtige doek. Gebruik geen schurende poetsmiddelen.

RU Очищайте от пыли тряпкой или слегка влажной ветошью. Не допускается применение чистящих средств, не предназначенных для ухода за мебелью.

RO Curățarea trebuie efectuată numai cu o cârpă sau cu un prosop ușor umezit. Nu utilizați agenți de curățare abrazivi.





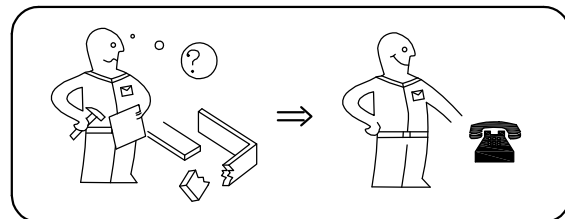
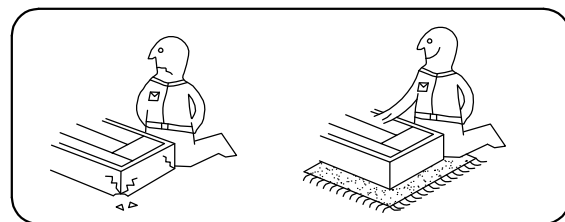

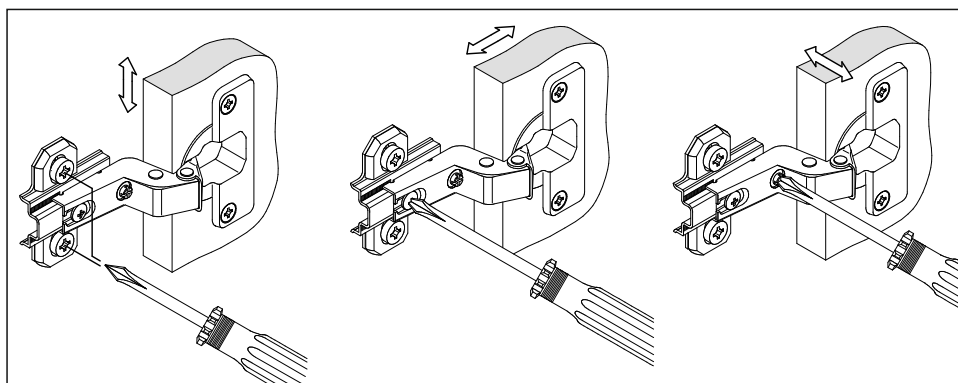
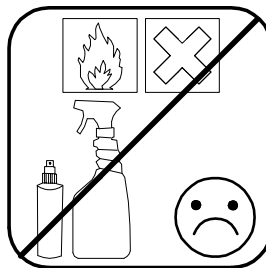
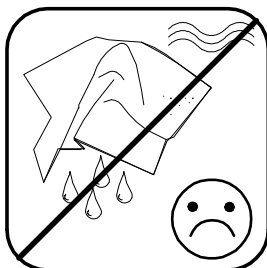
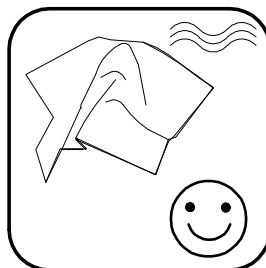
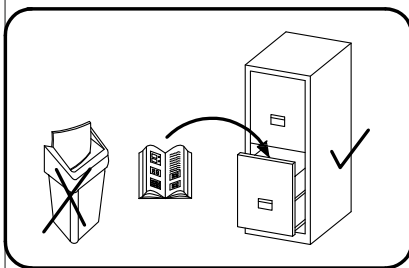

SK Čistení je nutné vykonávať výhradne pomocí utierky alebo ľahko zvlhnutým ručníkom. Nepoužívajte čistiace prostriedky obsahujúce abrazívne častice.

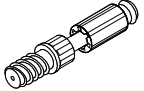
TR Lütfen sadece bir toz bezilye veya hafif nemli yumuşak bir bezle siliniz. Aşındırıcı temizlik malzemeleri kullanmayınız.

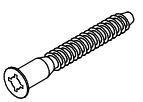

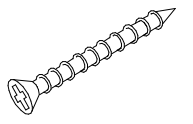
Karta serwisowa • Servisní list • Service Karte • Service card • Carte de service • Szervizkártya
Scheda di servizio • Service kaart • Сервисная карта • Fisa service • Servisný list • Servis karti

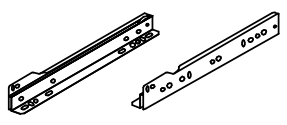
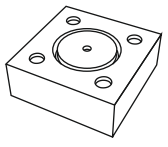
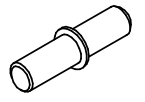
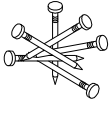

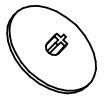
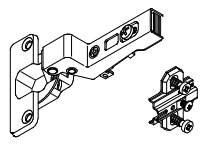
1		2		5	7x50	6	6,3x10,5	14	3,5x30
									
14 x		14 x		67 x		24 x		6 x	
15		18	3,5x15	23	350 mm	38		39	DUPLO
									
1 x		26 x		1 x		6 x		20 x	
48	2x20	72		73		90	Hinge C		
									
60 x		47 x		14 x		10 x			

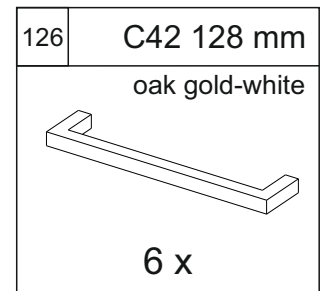
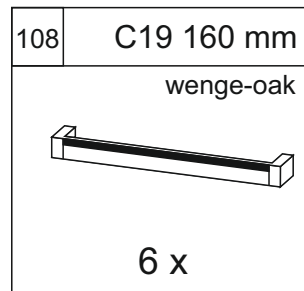
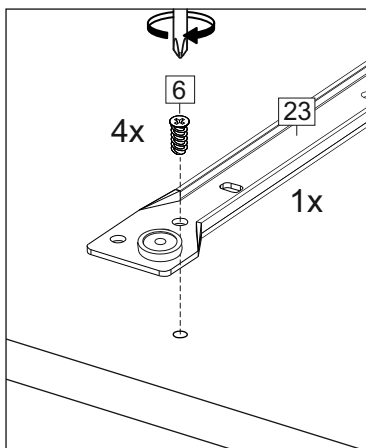

или/
or

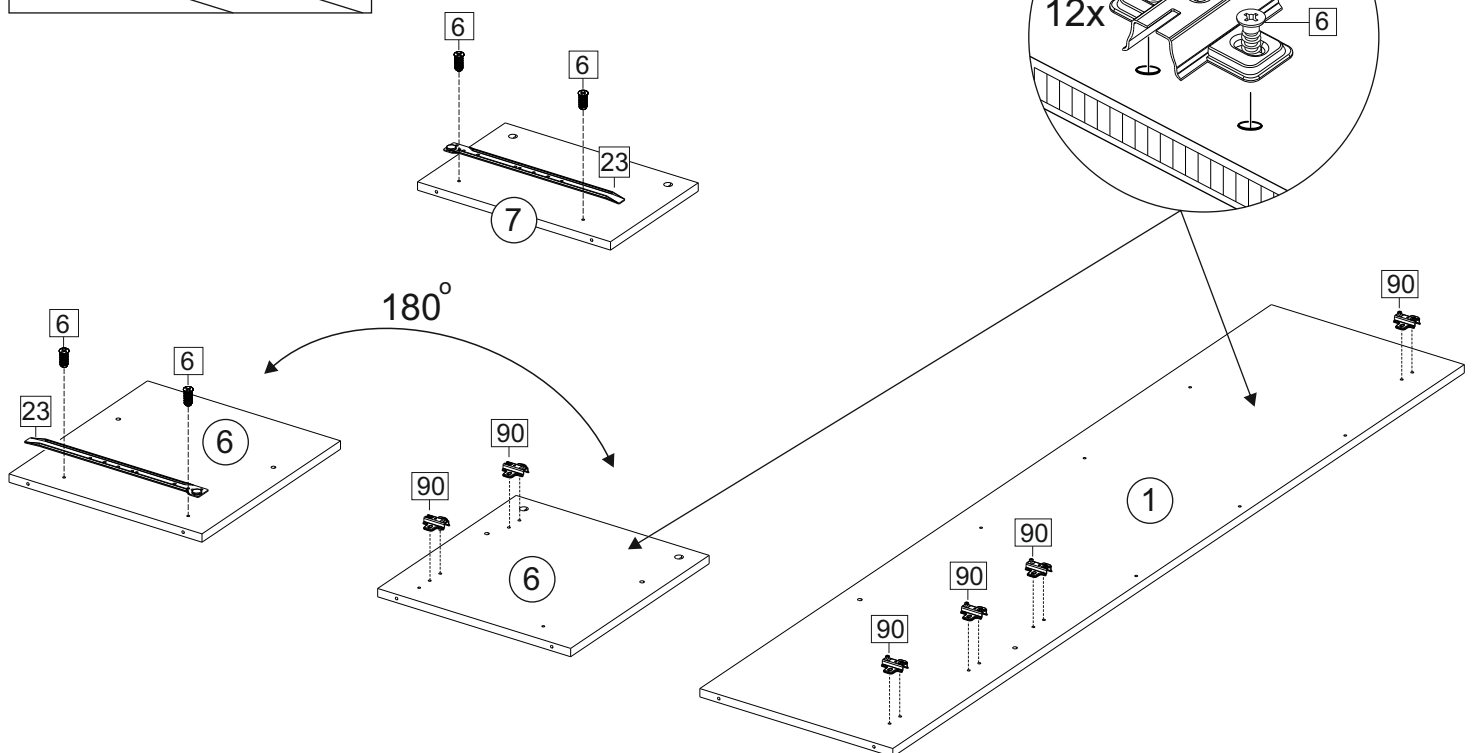

4

